

# INSTALLATION MANUAL

For the most current release of this manual,  
please visit our website at [cogan.com](http://cogan.com)

V.2016.1

## DEA CAGE SPECIFICATIONS AND DETAILS

Cogan DEA cages meet both the US Drug Enforcement Administration's requirements for physical security of [Schedule III through IV controlled substances as stipulated in Title 21 CFR Sections 1301:72-1301.76 physical security controls](#), and the [Health Canada Directive on Physical Security Requirements for Controlled Substances](#). Below are the details that differentiate from standard Cogan Safegarde partitions.

### 1- Specific mesh required



DEA Cages within the United States require 1" x 1" or 1" x 2" welded wire mesh.

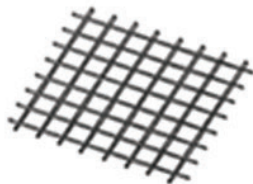

1"x 1" Welded wire mesh 10GA (0.135)

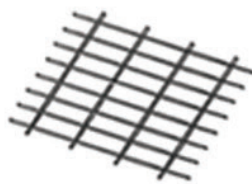

2"x 1" Welded wire mesh 10GA (0.135)



DEA Cages within Canada require flattened expanded metal 10GA with 1" x 2" diamond shaped openings.

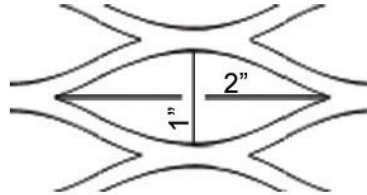

Flattened expanded metal 10GA with 1" x 2" diamond shaped openings

PLEASE VERIFY THE SECURITY REQUIREMENTS OF YOUR PROJECT IN ORDER TO SELECT THE APPROPRIATE TYPE OF MATERIAL.

Product	Partitions
Sub-product	DEA Cage - specifications

- This manual contains the details that differentiate from standard Cogan Safegarde<sup>®</sup> partitions.

- Refer to the installation drawings of your project for specific details and assembly note.



A Tradition of Quality Since 1901

[cogan.com](http://cogan.com)

## 2- Panels

All DEA cage panels are mounted with (2" sweep) a 2"x 2", 2"x 4" or 2"x 6" posts.

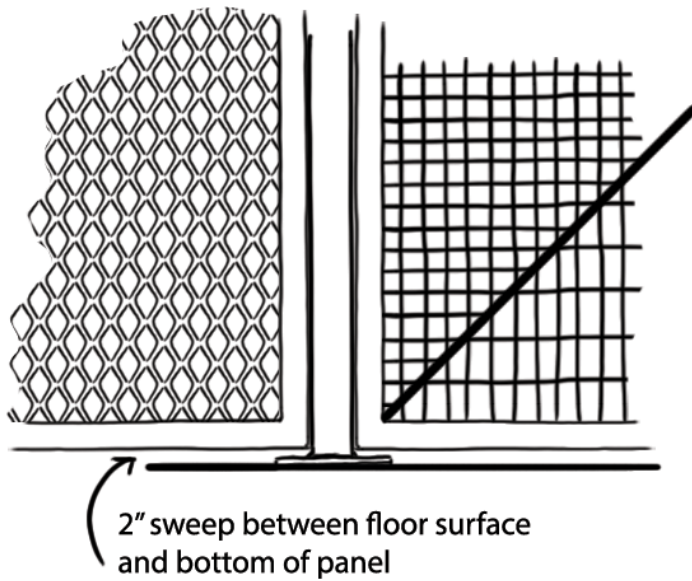

OPTIONAL: 2" gap can be covered by 1 1/4" x 1 1/4" angle to create a 3/4" sweep.

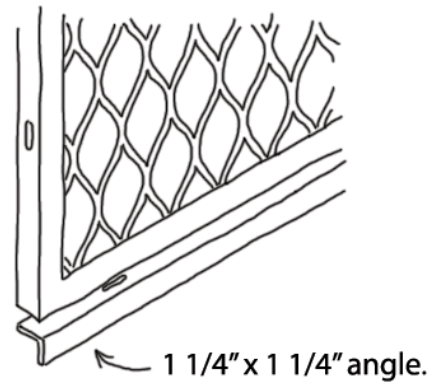

## 3- Self-Closing doors

Specially designed self-closing doors: inclined sliding track system for sliding doors and spring-loaded hinges for swing doors.

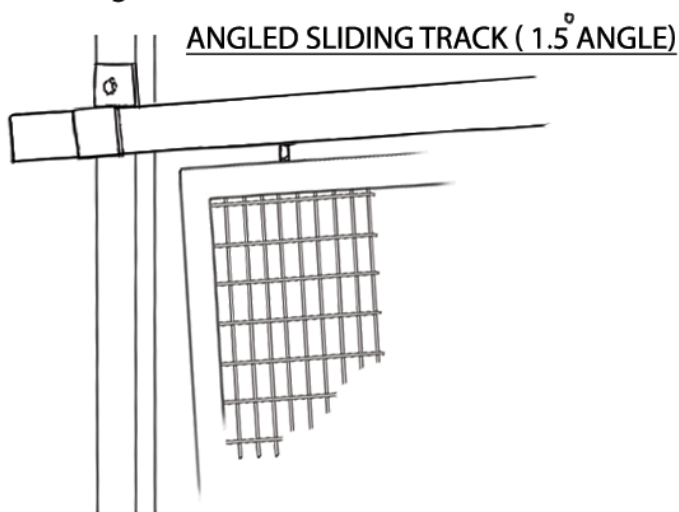

### SPRING-LOADED HINGES

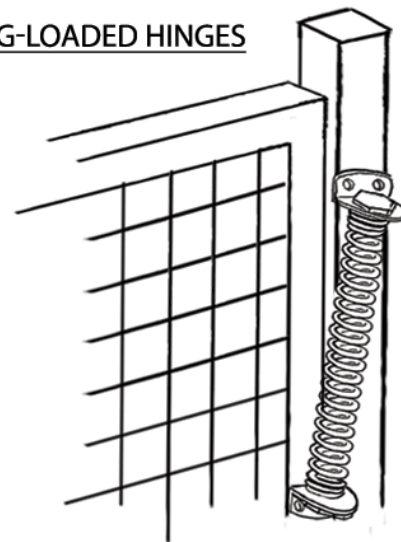

## 4- Roofs

Roof panels meet the same material specifications if the security enclosure does not reach the structural ceiling of the building.

**Roofs are non-load bearing.**

## 5- Hardware

Components are fastened with tamper-proof, anti-theft nuts and bolts.



## 6- Locks

Cogan will provide a mounting plates or other materials to help for the Install of your Locking Mechanism.